



YANMAR

SV26

MINI EXCAVATOR



Operating weight

2 600 kg (Canopy) / 2 740 kg (Cabin)

Engine

3TNV82A

Digging force (arm)

14.5 kN

Digging force (bucket)

24.5 kN

EXCELLENT PERFORMANCE IN A COMPACT PACKAGE





COMPACTNESS

The SV26 has been designed to meet all your requirements, and this while executing the most complicated jobs. Compact and lightweight, it can easily be transported on a trailer. Its stability and power enable it to work effectively regardless of the difficulty of your jobsite. The SV26 is intended for a wide range of applications such as urban renewal, grading or landscaping.



YANMAR ENGINE

The YANMAR TNV engine has been designed to combine high power and cleaner emissions. With its sophisticated injection system, it meets the European Commission (EC) emission standards. Its quiet operation makes this engine friendly to people and the environment.



BEST COMPONENTS

Design and performance of the components made for heavy-duty job sites and long service life.



MAINTENANCE

Simple maintenance structure for fast and easy access to all components. Facilitated daily checks.



CABIN

The use of a ROPS structure for the cab guarantees the operator safety in a roll-over. The canopy and cab also conform to FOPS1 standards (concerning structures protecting against falling objects) and TOPS (Tip Over Protective Structure).



EASE OF USE

Ideally located, the second gear control knob (located on the blade lever) and the control levers offer exceptional movement precision. To optimize control and ergonomics, all work controls are located on the machine's right console. A proportional control auxiliary line allows the use of many accessories such as a hammer or an auger.



COMFORT

The SV26 cab interior architecture has been studied to improve the operator driving position and to facilitate his work, particularly on the long and challenging work sites.

UNMATCHED STABILITY



The SV26 has excellent performance in a compact package. It is ideal for urban work and for landscaping. Its low ground pressure provides excellent efficiency on all types of terrain and decreases soil degradation.

COMPACT SIZE FOR EASY TRANSPORT

- + The transportation weight is only 2.665 kg* and its very compact undercarriage enables the SV26 to be transported with its accessories on a trailer.

*Cab version and rubber tracks.



HIGH PERFORMANCE



Based on our unique experience and expertise, Yanmar technology ensures excellent performance while respecting the environment. The optimal combination of the SV26 excavation strengths and its work cycles assures exceptional productivity.

VIPPS® HYDRAULIC SYSTEM (3 PUMP PROGRESSIVE VIO SYSTEM)

The SV26 has a hydraulic circuit with power summation regulation equipped with 2 variable flow piston pumps, a gear pump and a multiple combination directional control valve. Pumps engage automatically depending on the operation being

performed, providing greater ease of use for the operator. On the one hand, the cumulative flow of the pumps allows increasing the speed of work and on the other hand, the system allows smooth and simultaneous operations, even while travelling.

REDUCED FUEL CONSUMPTION

The SV26 consumes less than 4 liters per hour. This consumption can be further reduced by installing an optional Auto - Idling System which turns down the engine speed to idle when the machine has not been used for more than 4 seconds, then accelerates automatically when needed.



COMFORT

LARGE AND COMFORTABLE CABIN

The SV26 cab interior is very spacious for maximum freedom of movement. The large legroom allows the operator to work comfortably for long hours. The entrance, which is also very large, provides easy cab access and exit.

The standard SV26 seat has a comfortable suspension with multiple adjustments and is equipped with a headrest to reduce operator stress and fatigue.

EXCELLENT AIR CIRCULATION

The SV26 has a heater that can work at a pleasant temperature in extreme weather conditions. The vents are placed to ensure a uniform temperature within the cabin and ensure a perfect window demisting.



DIGITAL INTERFACE

The SV26 is equipped with a digital interface which informs the operator in real time about the status of his machine. Perfectly integrated into the right hand console, the 3.3" screen provides excellent visibility. The interface provides the customer with useful information through LED lamps, or indications about important elements like fuel consumption, fuel gauge, coolant temperature gauge, etc...

The interface assists the customer for maintenance intervals and to program such interventions. It also works as a diagnostic tool in case of malfunction by sending an error code and an information icon on the display.

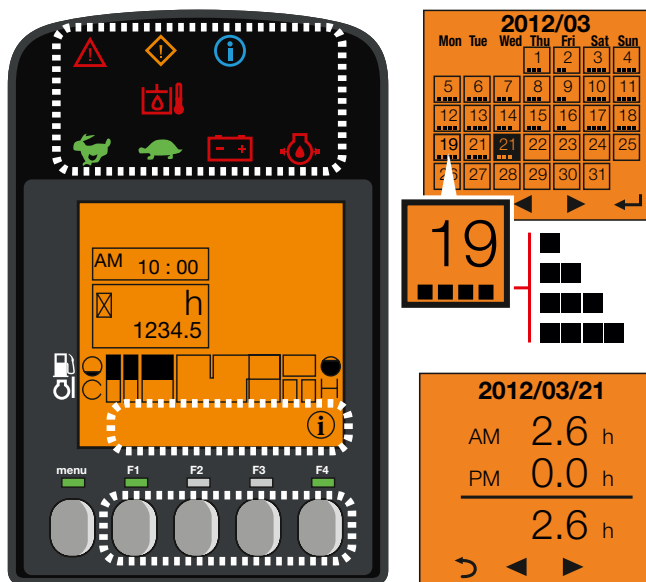

SAFETY

OPTIMUM VISIBILITY FOR EFFICIENT AND SAFE WORK

The large cab windows and the shape of the SV26 covers offer the operator a perfect view. The front windshield is divided into two parts with its top part retractable. This excellent visibility ensures optimal job site safety and reduces the risk of damaging the machine, especially in tight spaces or congested job sites. The transparent front part of the roof offers perfect control during loading and demolition operations.

The SV26 is equipped with 3 rear and side view mirrors. The operator can control the work area as well as the area around the machine without moving from his seat. In order to work efficiently and accurately in darkness, the SV26 comes with a standard LED light positioned in the lower part of the boom, where it is protected from shocks. The LED technology provides a powerful light while reducing energy consumption and increasing the life of the battery. A beacon and 3 additional LED lamps can optionally be added on the cab.



MAINTENANCE AND RELIABILITY

The SV26 perfectly meets the reputation for quality and durability of the Yanmar machines. The excellent accessibility to components, speed of maintenance and cleaning operations allow achieving excellent levels of onsite availability.

DESIGNED TO LAST

- + Structure of the chassis and durable steel covers provide foolproof resistance.
- + Large counterweight protects against possible shocks and friction against the walls.
- + Hoses protection with abrasion-resistant sleeves. Routing on the top of the boom and on the right side of the machine to avoid risk of torsion and limiting machine down time.
- + Connections of the cylinders to the blade and the boom fully protected by steel plates.
- + Form stringers prevents accumulation of soil and reduces internal track wear.
- + Machine operating temperature reduced, contributing to extending the life of the components.

EASY MAINTENANCE

The rear and side covers, the panel under the seat and the removable floor provide direct access to the service points to reduce the maintenance time and cost. The blade cylinder flexible is made of two parts for quick replacement in case of perforation.



EQUIPMENT

[STANDARD EQUIPMENT]

PERFORMANCE

3TNV82A Yanmar diesel | Meets EN standards | Direct injection | VIPPS Hydraulic system (ViO Progressive 3 Pump System) | 1 auxiliary circuit with proportional control | Automatic 2nd speed | Hydraulic oil gauge | 1 LED light integrated into the boom.

COMFORT

LCD Interface | Cab mounted on viscoelastic rubber blocks | Fabric covered, adjustable and reclining seat on suspension with headrest | Adjustable wrist support | Foot rests | Wide travel pedals | Windshield in 2 parts (retractable upper part) | Double sliding right side window | Transparent upper front part | Wipers | Windshield washer | Automatic ceiling lamp | 2 x 12V outlets | Storage boxes | Lockable document storage | Cup holder.

SAFETY AND DURABILITY

Handrails | Safety lever | Safety belt | Hammer for evacuation | 3 mirrors | Travel beep | Anchor points | Blade cylinder supply hose into two parts | Complete protection of the cylinders (blade, arm and boom) | Hoses protected by abrasion resistant sleeves | Cataphoresis treated steel parts | Locking covers.

MISCELLANEOUS

Fuel gauge | Tool kit | Grease pump.

[OPTIONAL EQUIPMENT]

EQUIPMENT AND PERFORMANCE

Special paint | Long arm | Additional counterweight | Potentiometer | 2nd auxiliary circuit with proportional control | 1/2 circuit | Quick connects | Auto-idling system | Bio oil | 2 LED head lights on the front of the machine | 1 LED light + beacon to the rear of the machine.

COMFORT AND EASE OF USE

Skaï seat | Radio | Centralised greasing.

SAFETY AND DURABILITY

Safety valves for lifting + overload warning | Anti-theft device (Key/Keypad) | Travel alarm.

[ATTACHMENTS]

Yanmar gives you the attachments that fit your needs and match the safety standards in force in your country: mechanical quick coupler, hydraulic quick coupler, ditching bucket, swinging bucket, backhoe bucket, hydraulic hammer...

DIMENSIONS

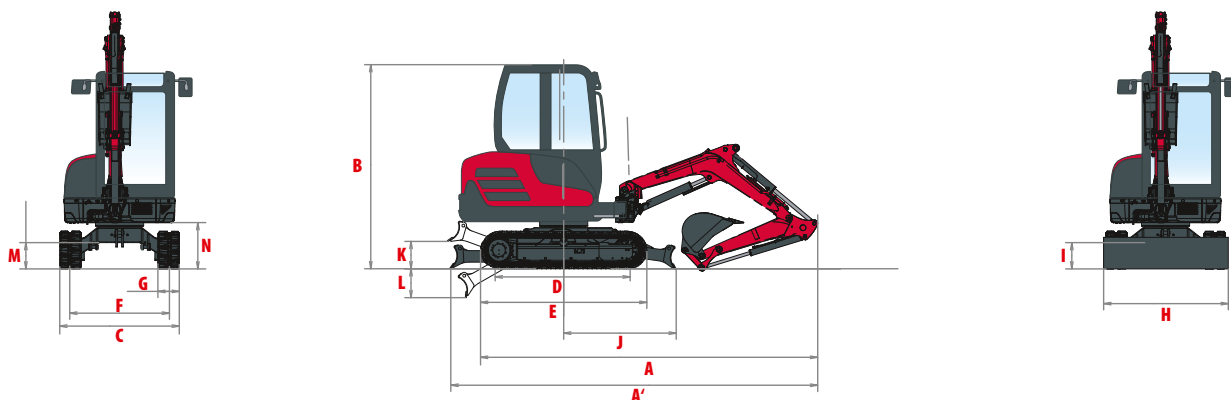

A Overall length	4 250/4 295* mm	H Overall blade width	1 550 mm
A' Overall length with blade at the back	4 470/4 515* mm	I Overall blade height	280 mm
B Overall height	2 400/2 440* mm	J Blade distance	1 380 mm
C Overall width	1 550 mm	K Max. blade height above the ground	300 mm
D Length of track on ground	1 550 mm	L Max. lowering blade depth	350 mm
E Undercarriage length	2 030 mm	M Minimum ground clearance	320 mm
F Lane	1 250 mm	N Ground clearance under counterweight	540 mm
G Track width	250 mm		

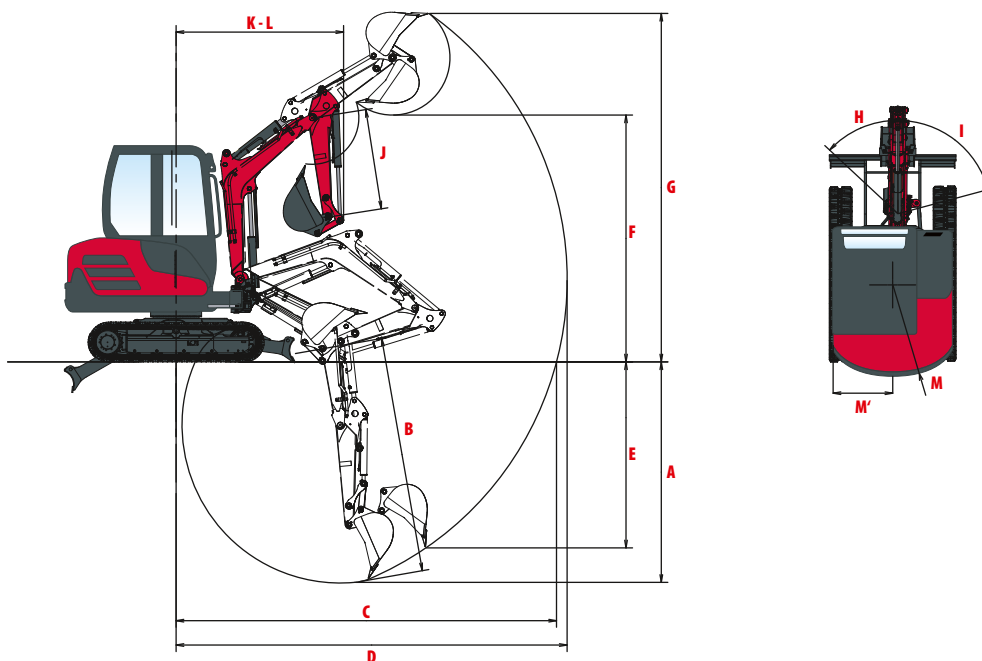

A Max. digging depth - Blade lifted	2 520/2 770* mm	H Boom swinging base to left	45°
B Max. digging depth - Blade lowered	2 690/2 950* mm	I Boom swinging base to right	75°
C Max. digging reach on ground	4 340/4 600* mm	J Arm length	1 150/1 400* mm
D Max. digging reach	4 460/4 710* mm	K Minimum front swing radius	1 915/1 975* mm
E Max vertical wall	920/1 120* mm	L Minimum front swing radius with boom swing	1 615/1 670* mm
F Max. dumping height	2 830/2 980* mm	M Rear turning radius	1 160 mm
G Max. cutting height	3 980/4 130* mm	M' Rear turning radius with additional counterweight	1 240 mm

* With long arm.
Subject to technical modifications. Dimensions in mm with specific Yanmar bucket







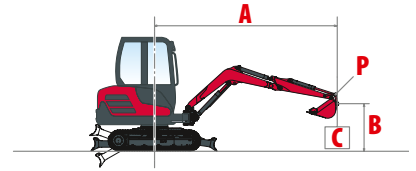











LIFTING FORCE

 Tipping load, rating over front



















 Tipping load, rating over side 90°





















Standard arm, standard counterweight

Cabin										Canopy											
Blade on ground / Blade above ground										Blade on ground / Blade above ground											
A	(A)	Max.		3,5 m		3 m		2,5 m		2 m		(A)	Max	3,5 m		3 m		2,5 m		2 m	
B																					
2,5 m	3,5/3,5	*515/515	*515/515	-	-	*525/525	*525/525	-	-	-	-	3,5/3,5	405/405	*515/515	-	-	*525/525	*525/525	-	-	-
2 m	3,58/3,6	*535/535	*535/535	*530/530	*530/530	*560/560	*560/560	*570/570	*570/570	-	-	3,6/3,6	375/375	*535/535	*530/530	*530/530	*560/560	*560/560	*570/570	*570/570	-
1,5 m	3,75/3,9	*540/420	*540/420	*550/440	*550/440	*585/585	*585/585	*705/705	*705/705	*915/915	*915/915	3,8/3,9	350/345	*540/400	*550/400	*550/400	*585/585	*585/585	*705/705	*705/705	*915/915
1 m	3,8/3,8	*545/370	*545/370	*590/420	*590/420	*695/525	*695/525	*700/880	*815/890	*1040/1040	*1040/1040	3,77/3,77	340/330	*545/350	*545/350	*590/380	*475/465	*695/685	*635/635	*815/815	*800/1040
0,5 m	3,7/3,79	*555/370	*555/370	*620/410	*620/410	*725/515	*725/515	*725/670	*920/930	*1355/1120	*1355/1120	3,73/3,73	330/335	*555/370	*555/370	*620/430	*465/450	*725/550	*610/730	*920/820	*1355/1025
0 m	3,65/3,7	*580/370	*580/370	*610/415	*610/415	*760/510	*760/510	*760/640	*935/900	*1035/1050	*1035/1050	3,65/3,65	340/335	*580/370	*580/370	*610/365	*405/450	*760/535	*595/580	*935/835	*1335/955
-0,5 m	3,5/3,64	*575/390	*575/390	*500/400	*500/400	*560/500	*560/500	*750/645	*985/905	*1250/1100	*1250/1100	3,64/3,64	350/355	*575/375	*560/360	*460/450	*750/545	*585/580	*985/925	*825/820	*1250/1000
-1 m	3,1/3,23	*580/430	*580/430	-	-	*505/500	*610/610	*645/830	*930/930	*1105/1105	*1105/1105	3,23/3,23	385/385	*580/515	-	-	*610/450	*580/575	*830/840	*840/895	*1105/1105
-1,5 m	2,7/2,7	*540/540	*540/540	-	-	-	-	*580/580	*580/580	*765/810	*765/810	2,7/2,7	410/410	*540/540	-	-	-	*440/580	*580/570	*810/555	*810/810



















Long arm, standard counterweight

Cabin										Canopy											
Blade on ground / Blade above ground										Blade on ground / Blade above ground											
A	(A)	Max.		3,5 m		3 m		2,5 m		2 m		(A)	Max	3,5 m		3 m		2,5 m		2 m	
B																					
2,5 m	3,67/3,67	*455/455	*455/455	*465/465	*465/465	*435/435	*435/435	-	-	-	-	3,67/3,67	355/350	*455/455	*465/465	*465/465	-	-	-	-	-
2 m	3,9/3,9	*470/370	*470/370	*470/470	*470/470	*480/480	*480/480	-	-	-	-	3,9/3,9	330/330	*470/470	*470/470	*470/470	*480/480	*480/480	-	-	-
1,5 m	3,98/3,98	*485/345	*485/345	*495/485	*495/485	*535/535	*535/535	*610/610	*610/610	-	-	3,98/3,98	310/310	*485/375	*495/495	*495/495	*535/535	*535/535	*610/610	*610/610	-
1 m	4,05/4,05	*480/340	*480/340	*545/425	*545/425	*620/620	*620/620	*770/770	*770/770	*1050/1050	*1050/1050	4,05/4,05	310/310	*490/350	*385/375	*454/420	*480/480	*620/620	*770/770	*770/770	*1050/1050
0,5 m	4/4	*515/350	*515/350	*520/410	*520/410	*585/510	*585/510	*690/650	*690/650	*885/840	*885/840	4/4	300/300	*515/380	*585/375	*585/375	*690/460	*690/460	*885/850	*850/925	*1250/1010
0 m	3,91/3,91	*520/345	*520/345	*590/400	*590/400	*730/505	*730/505	*920/650	*920/650	*1320/920	*1320/920	3,91/3,91	310/310	*520/360	*590/360	*590/360	*730/510	*585/585	*920/890	*800/890	*1320/1010
-0,5 m	3,3/3,3	*530/385	*530/385	*410/400	*410/400	*500/490	*500/490	*700/630	*845/830	*925/915	*1050/1080	3,3/3,3	315/305	*530/415	*560/425	*440/440	*510/510	*570/570	*835/825	*915/990	*1155/990
-1 m	3,5/3,5	*545/380	*545/380	-	-	*490/490	*610/610	*630/835	*880/880	*1110/1110	*1110/1110	3,5/3,5	340/340	*545/430	-	-	*440/490	*570/560	*835/665	*930/790	*1110/870
-1,5 m	2,95/2,95	*560/560	*560/560	-	-	-	-	*645/645	*830/830	*830/830	*830/830	2,95/2,95	405/405	*560/565	-	-	-	*510/505	*645/625	*830/830	*830/830

Standard arm, additional counterweight

Cabin										Canopy											
Blade on ground / Blade above ground										Blade on ground / Blade above ground											
A	(A)	Max.		3,5 m		3 m		2,5 m		2 m		(A)	Max	3,5 m		3 m		2,5 m		2 m	
B																					
2,5 m	3,5/3,5	*515/515	*515/515	-	-	*525/525	*525/525	-	-	-	-	3,5/3,5	*515/515	*515/515	-	-	*525/525	*525/525	-	-	-
2 m	3,58/3,6	*535/535	*535/535	*530/530	*530/530	*560/560	*560/560	*570/570	*570/570	-	-	3,6/3,6	425/425	*535/535	*530/530	*530/530	*560/560	*560/560	*570/570	*570/570	-
1,5 m	3,75/3,9	*540/420	*540/420	*550/440	*550/440	*585/585	*585/585	*705/705	*705/705	*915/915	*915/915	3,8/3,9	400/390	*540/455	*550/440	*550/440	*585/585	*585/585	*705/705	*705/705	*915/915
1 m	3,8/3,8	*545/370	*545/370	*590/420	*590/420	*695/525	*695/525	*700/880	*815/890	*1040/1040	*1040/1040	3,77/3,77	385/380	*545/350	*545/350	*590/440	*475/465	*695/685	*720/720	*815/815	*1040/1040
0,5 m	3,7/3,79	*555/370	*555/370	*620/410	*620/410	*725/515	*725/515	*725/670	*920/930	*1035/1010	*1035/1010	3,73/3,73	380/380	*555/440	*555/440	*620/420	*465/510	*725/615	*685/815	*920/890	*1355/1145
0 m	3,65/3,7	*580/370	*580/370	*610/415	*610/415	*760/510	*760/510	*760/640	*935/900	*1035/1035	*1035/1035	3,65/3,65	380/385	*580/425	*580/425	*610/460	*525/510	*760/660	*680/665	*951/915	*1335/1075
-0,5 m	3,5/3,64	*575/390	*575/390	*500/400	*500/400	*560/500	*560/500	*750/645	*985/905	*1250/1100	*1250/1100	3,64/3,64	380/405	*575/415	*560/415	*460/450	*750/545	*585/580	*985/805	*940/930	*1250/1120
-1 m	3,1/3,23	*580/430	*580/430	-	-	*570/560	*610/610	*735/830	*930/930	*1000/1105	*1105/1105	3,23/3,23	445/445	*580/530	-	-	*505/520	*610/665	*830/830	*930/810	*1105/1105
-1,5 m	2,7/2,7	*540/540	*540/540	-	-	-	-	*580/580	*580/580	*810/810	*810/810	2,7/2,7	*540/540	*540/540	-	-	-	*580/580	*580/810	*810/810	*810/810

Long arm, additional counterweight

Cabin										Canopy											
Blade on ground / Blade above ground										Blade on ground / Blade above ground											
A	(A)	Max.		3,5 m		3 m		2,5 m		2 m		(A)	Max	3,5 m		3 m		2,5 m		2 m	
B																					
2,5 m	3,5/3,5	*455/455	*455/455	*465/465	*465/465	*435/435	*435/435	-	-	-	-	3,67/3,67	395/385	*455/455	*465/465	*465/465	-	-	-	-	-
2 m	3,9/3,9	*470/370	*470/370	*470/470	*470/470	*480/480	*480/480	-	-	-	-	3,9/3,9	380/375	*470/470	*470/470	*470/470	*480/480	*480/480	-	-	-
1,5 m	3,75/3,9	*485/340	*485/340	*495/485	*495/485	*535/535	*535/535	*610/610	*610/610	-	-	3,98/3,98	355/355	*485/375	*495/495	*495/495	*535/535	*535/535	*610/610</		

TECHNICAL SPECIFICATIONS

[WEIGHT +/- 2% (EN STANDARDS)]

	Cabin		Canopy	
	Weight	Ground pressure	Weight	Ground pressure
Operating weight (rubber/steel tracks)	2 740/2 824 kg	0.27/0.33 kgf/cm ²	2 600/2 684 kg	0.26/0.32 kgf/cm ²
Transport weight (rubber tracks)	2 665/2 749 kg	0.26/0.33 kgf/cm ²	2 525/2 609 kg	0.25/0.31 kgf/cm ²
With additional counterweight	+ 100 kg	-	+ 100 kg	-

[ENGINE]

Type	3TNV82A-BPBVA
Fuel	Diesel
Regulation	Stage V
Net Power	17.6 kW at 2400 rpm
Gross Power	18.1 kW at 2400 rpm
Displacement	1.331 liters
Maximum torque	78.6 – 85.5 N.m (1400 +/- 8-8.7 rpm)
Cooling	Water-cooling
Starter	12 V - 2,3 kW
Battery	12 V – 56 Ah
Alternator	12 V - 40 A

[HYDRAULIC SYSTEM]

Maximum pressure	210 bars
1 double piston pump with variable flow	2 x 32,4 l/min
1 gear pump	21,6 l/min
1 gear pump	10,8 l/min

PTO	Measured data at max. engine speed	
	Pressure	Flow
2 ways	0 - 200 bars	56 – 8.5 l/min
1 way	0 - 200 bars	56 – 8.5 l/min

 Oil flow decreases as the pressure increases

[PERFORMANCE]

Travel speed	2.9/4.8 km/h
Rotation speed	10.2 rpm
Digging force (arm)	14.5 kN/12.7 kN with long arm
Digging force (bucket)	24,5 kN
Traction force	37 kN
Grade ability	30°
Noise level (2000/14/CE & 2005/88/CE)	LwA: 94 dBA/LpA: 76 dBA

[UNDERCARRIAGE]

Number of top rollers	1
Number of bottom rollers	3
Track tensioning system	Grease adjuster

[CAPACITIES]

Fuel tank	38.5 l
Coolant	3.8 l
Engine oil	3.7 l
Hydraulic circuit (including hydraulic tank)	30 l
Hydraulic tank	25.2 l

MAINTENANCE FREQUENCY

[Change engine oil and filter: **500 hours**] [Change fuel filter: **250 hours**] [Clean hydraulic oil filter: **500 hours**] [Change hydraulic oil: **500 hours**] [Change hydraulic oil return filter: **500 hours**] [Change cooling fluid: **2 000 hours**]



YANMAR



Yanmar Compact Equipment EMEA

GB_SV26_0622



www.yanmar.com

BUILDING
WITH YOU

Printed in France – Materials and specifications are subject to change from the manufacturer without notice – Please contact your local Yanmar Compact Equipment EMEA dealer for further information.